

DATA SHEET

U 5.201

ROTARY VANE- VACUUM PUMPS

oil-lubricated

air-cooled

MAKE IT BECKER.



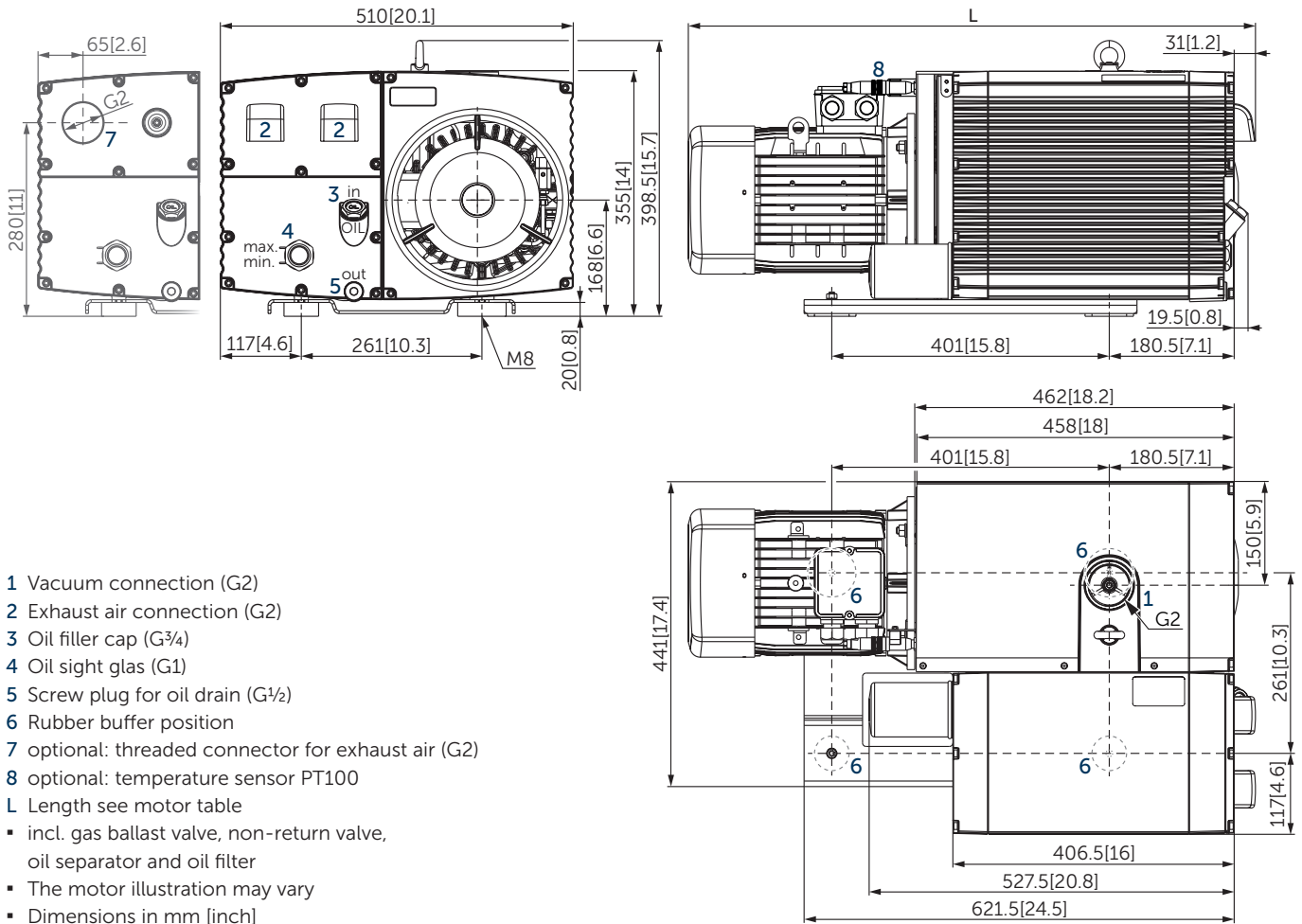

- 1 Vacuum connection (G2)
- 2 Exhaust air connection (G2)
- 3 Oil filler cap (G³/₄)
- 4 Oil sight glas (G1)
- 5 Screw plug for oil drain (G¹/₂)
- 6 Rubber buffer position
- 7 optional: threaded connector for exhaust air (G2)
- 8 optional: temperature sensor PT100
- L Length see motor table
- incl. gas ballast valve, non-return valve, oil separator and oil filter
- The motor illustration may vary
- Dimensions in mm [inch]

Nominal capacity		Vacuum absolute for continous operation		Motors		Emission sound pressure level ¹⁾		Weight w/o motor	Oil ²⁾
m ³ /h		mbar		kW		dB(A)		kg	l
50 Hz	60 Hz	50 Hz	60 Hz	50 Hz	60 Hz	50 Hz	60 Hz		
200	240	<0.1–100	<0.1–100	4.0	4.5/4.8	72	74	68	5
200	240	<0.1–400	<0.1–400	5.5	6.6	72	74	68	5

¹⁾ According to DIN EN ISO 11203, accuracy class of measurement: class 2, extended measurement uncertainty: 3 dB
 1 m [39.4 inch] distance, at medium load, both connection sides piped

²⁾ Becker Lube M100 mineral • S100 synthetic • SL100 food

▪ Gas ballast valve: vacuum 1.0 mbar absolute with opened gas ballast valve; water vapour tolerance max. 7 mbar; water vapour capacity max. 0.3 l/h (at 85°C operating temperature)

3~ Motors													L
#	50 Hz					60 Hz					Version	Weight kg	mm [inch]
	kW	V	IE3	min ⁻¹	A	kW	V	IE3	min ⁻¹	A			
01	4.0	Δ230/Y400	IE3	1465	15.6/9.0	4.8	Δ265/Y460 Δ230/Y400	IE3 -	1760 1747	15.2/8.8 15.9/9.2	UL (E365362) • CSA IP 55 • ISO F • bimetal	40.0	854 [33.6]
02	4.0	YY200/Y400	IE3	1465	18.0/9.0	4.5	YY230/Y460 YY208	IE3 IE3	1759 1753	18.4/9.2 18.7	UL (E235514) • CSA CC329B IP 55 • ISO F • bimetal	40.0	854 [33.6]
03	4.0	Δ200/Y350	-	1467	20.3/11.7	4.5	Δ200/Y380-400 Δ200/Y350	IE3 -	1760 1753	18.5/10.7-10.2 19.0/11.0	UL (E235514) • CSA CC329B IP 55 • ISO F • bimetal	40.0	854 [33.6]
04						4.5	Δ400/Y690	IE3	1763	9.8/5.65	UL (E235514) • CSA CC329B IP 55 • ISO F • bimetal	40.0	854 [33.6]
05	5.5	Δ230/Y400	IE3	1468	20.7/12.0	6.6	Δ265/Y460 Δ230/Y400	IE3 -	1762 1750	20.6/11.9 21.6/12.5	IP 55 • ISO F • bimetal	53.0	885 [34.9]
06	5.5	Δ400	IE3	1468	12.3	6.6	Δ460 Δ400	IE3 -	1764 1751	12.0 12.4	IP 55 • ISO F • bimetal	53.0	885 [34.9]
07						6.6	YY230/Y460 YY208	IE3 -	1770 1760	23.9/12.0 24.2	UL (E365362) • CSA CC3348 IP 55 • ISO F • bimetal	63.5	923 [36.4]
08	5.5	Δ200/Y350	IE3	1474	27.4/15.8	6.6	Δ200/Y380-400 Δ200/Y350	IE3 -	1769 1761	25.1/14.5-13.8 25.4/14.65	UL (E365362) • CSA IP 55 • ISO F • bimetal	63.5	923 [36.4]

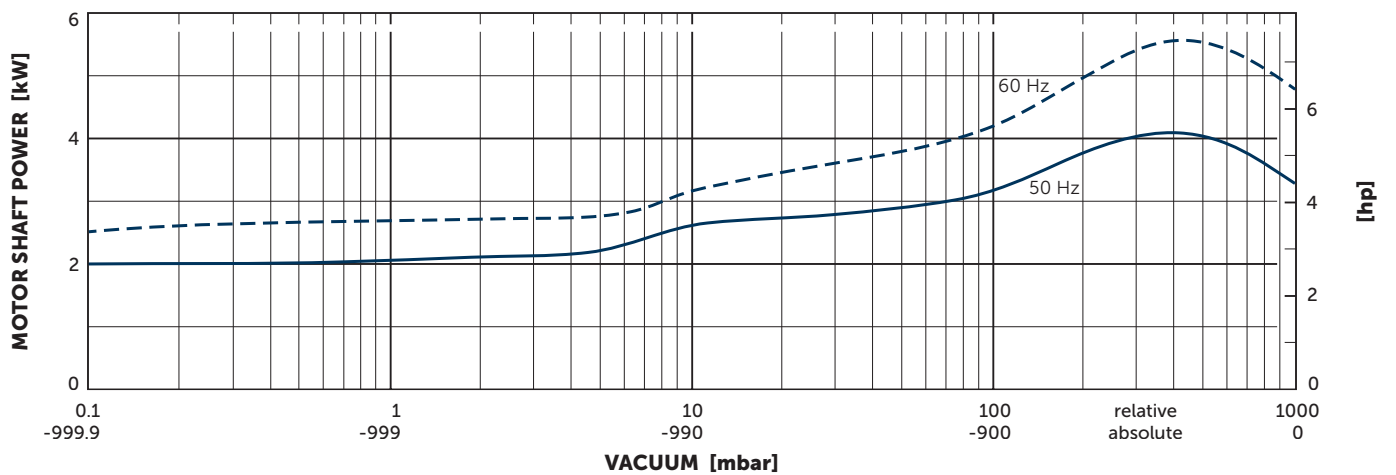
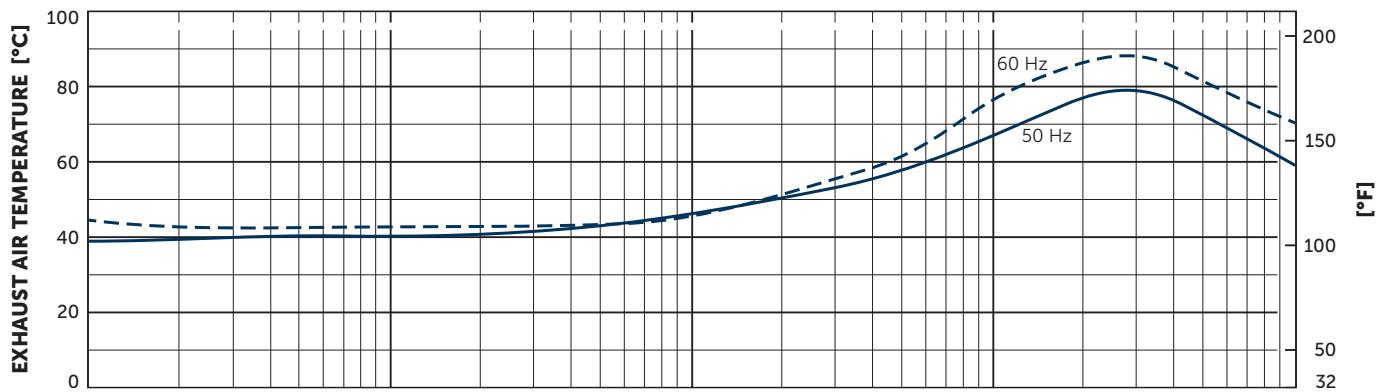
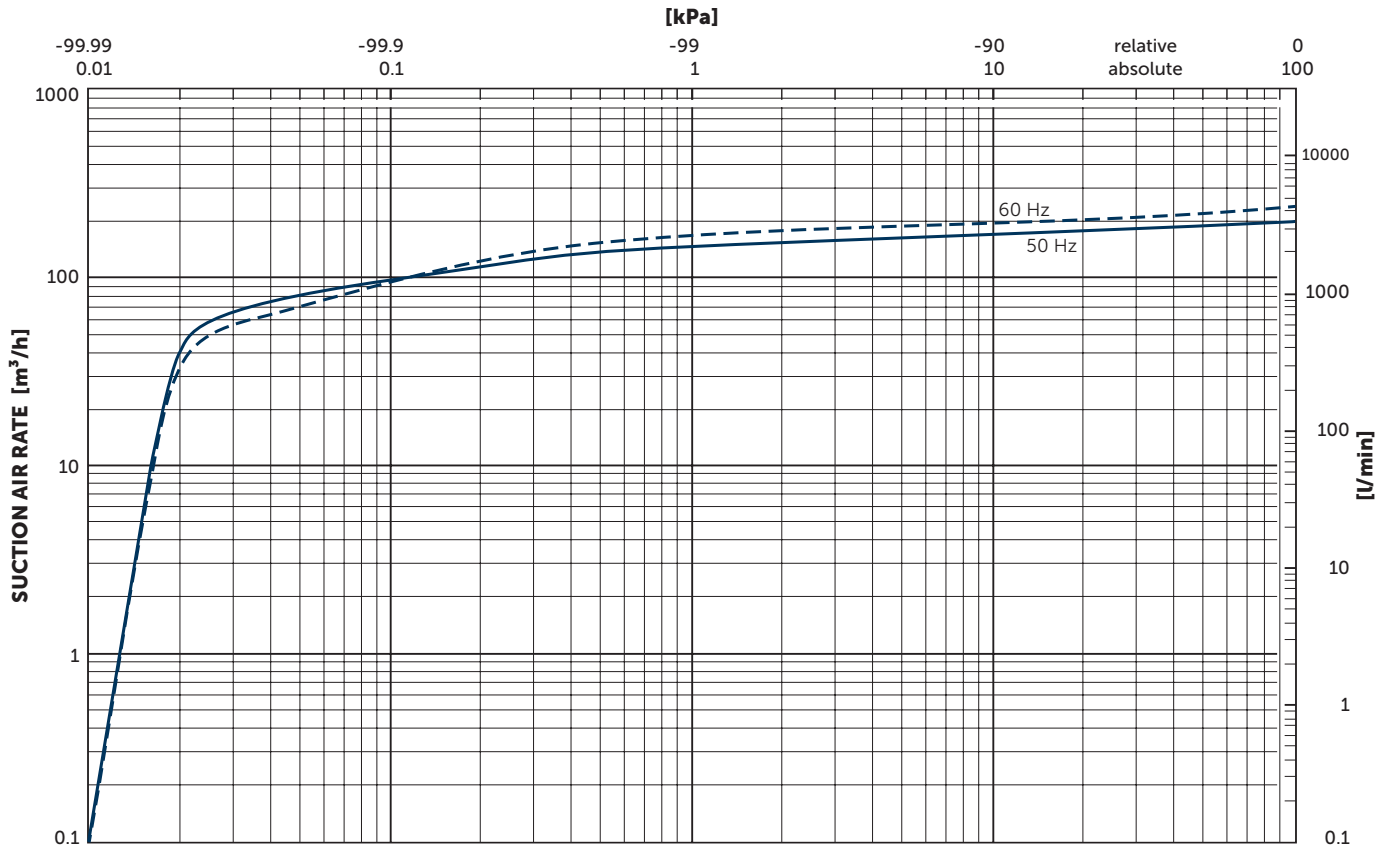

Suction air rate refers to the intake pressure
 Reference data (atmosphere): 1000 mbar (100 kPa), 20°C (68°F)
 Tolerance: $\pm 10\%$

+ VARIANTS AND ACCESSORIES

- Optional **GAS BALLAST VALVE** for increased water vapour tolerance (3.0 mbar absolute)
water vapour tolerance: max. 50 mbar; water vapour capacity: max. 2.0 l/h (at 85°C operating temperature)
- **THREADED CONNECTOR** for exhaust air (G2)
- **VARIAR U 5.201¹⁾** with VARIAIR frequency inverter
- **U 5.201 O2-PACK¹⁾** for packaging with an overconcentration of oxygen
- **U 5.201/0-62XL** with enlarged oil tank and high efficient triple stage oil separation,
weight without motor: 78 kg, oil quantity: 10 l, further technical data, motors and characteristic curves like standard pump

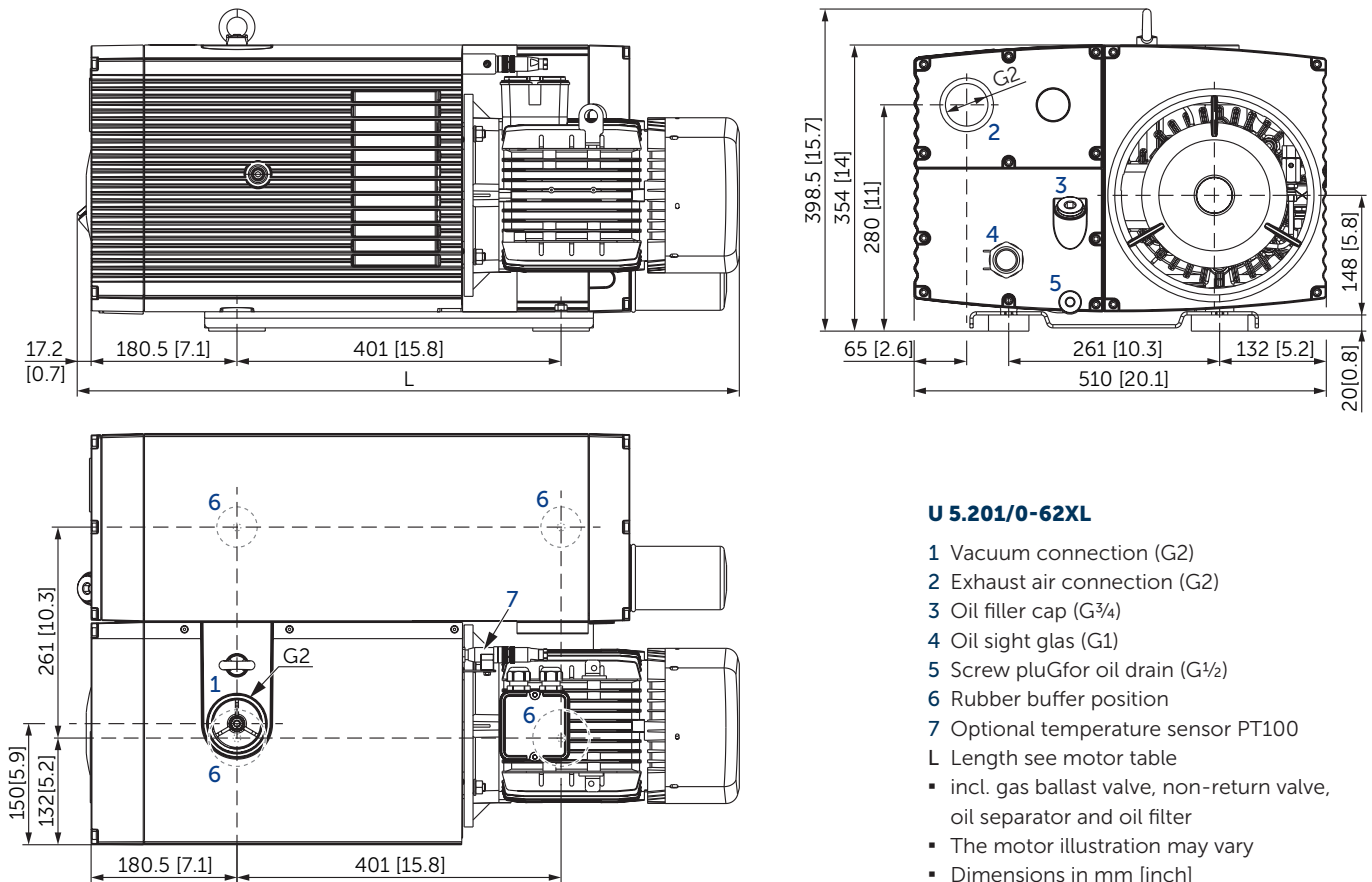

U 5.201/0-62XL

- 1 Vacuum connection (G2)
 - 2 Exhaust air connection (G2)
 - 3 Oil filler cap (G³/₄)
 - 4 Oil sight glass (G1)
 - 5 Screw plug for oil drain (G¹/₂)
 - 6 Rubber buffer position
 - 7 Optional temperature sensor PT100
- L Length see motor table
- incl. gas ballast valve, non-return valve, oil separator and oil filter
 - The motor illustration may vary
 - Dimensions in mm [inch]

ACCESSORIES

- 1 Oil level switch¹⁾ (G1)
 - 2 Oil temperature monitor¹⁾ (G¹/₂)
 - 3 Maintenance indicator¹⁾ (G³/₄) for oil separating elements
 - 4 Ball valve (G¹/₂), with locking and hose connector 19 mm (0.75 inch)
 - 5 Temperature sensor PT100
 - 6 Water cooler U5.200-0-114.2¹⁾ with connectors for hoses with an external diameter of 8 mm (0.32 inch)
- External suction filter
 - Oil: Becker Lube M100 mineral, S100 synthetic and SL100 food

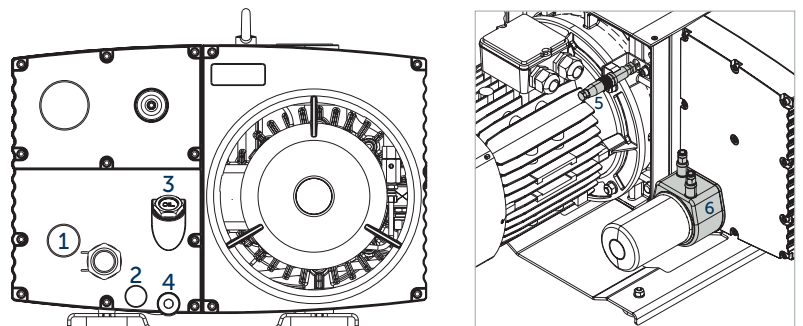

Oil level switch



Oil temperature monitor



Maintenance indicator

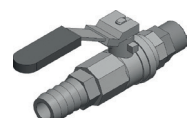

Ball valve

¹⁾ See separate data sheet
• Combination options on request



MAKE IT BECKER.